

- Este manual deve ser guardado para futura consulta, caso necessário.
- This manual should be retained for future reference, if necessary
- Este manual debe guardarse para futuras referencias, si es necesario.

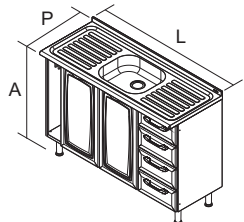

Nº	CÓDIGO CODE CÓDIGO	DESCRIÇÃO / DIMENSÃO (mm) DESCRIPTION / DIMENSION (mm) DESCRIPCIÓN / DIMENSIÓN (mm)	MATERIAL / ACABAMENTO Raw Material / FINISH MATERIA PRIMA / TERMINACIÓN	QUANTIDADE QUANTITY CANTIDAD
CORPO / CARCASS / CAJA				
01-	3000001339	LATERAL DIR IG3G4GD-105TL BRA / 690 X 402 X 18 MM	AÇO/STEEL/ACERO - BRANCO/WHITE/BLANCO	1
02-	3000004660	LATERAL ESQ IGNUV-15 BRA / 690 X 402 X 18 MM	AÇO/STEEL/ACERO - BRANCO/WHITE/BLANCO	1
03-	3000004669	DIVISAO ESQ IG3G4-120 NC CP BRA / 670 X 400 X 18 MM	AÇO/STEEL/ACERO - BRANCO/WHITE/BLANCO	1
04-	3000004666	FUNDO IG3G4-120 NC CP BRA / 1199 X 400 X 20 MM	AÇO/STEEL/ACERO - BRANCO/WHITE/BLANCO	1
05-	3000001056	FUNDO IG2-70 BRA / 699 X 400 X 20 MM	AÇO/STEEL/ACERO - BRANCO/WHITE/BLANCO	1
06-	3000004672	TETO IGNUV-15 CP BRA / 400 X 149 X 20 MM	AÇO/STEEL/ACERO - BRANCO/WHITE/BLANCO	1
07-	3000001044	CALHA SUPERIOR IG3GI-105 BRA / 1043 X 24 X 22 MM	AÇO/STEEL/ACERO - BRANCO/WHITE/BLANCO	1
08-	3000004663	COSTA IG3G4GD-120TL NC PIA BRA / 1197 X 690 X 15 MM	AÇO/STEEL/ACERO - BRANCO/WHITE/BLANCO	1
09-	3000000562	COLUNA IG3G4-120TL BRA / 660 X 30 X 11 MM	AÇO/STEEL/ACERO - BRANCO/WHITE/BLANCO	1
10-	1000001321	KIT GD PLASTICA TL BR 347X90	BRANCO/WHITE/BLANCO	4
11-	1000000301	SUPORTE PLÁSTICO TOALHEIRO / 115 X 45 X 25 MM	BRANCO/WHITE/BLANCO	2
12-	1000004279	ARAMADO PORTA TOALHA CP / 350 X 80 X 6 MM	CINZA/GRAY/GRIS	2
13-	3000004161	TAMPA PLAST FURO SAÍDA DE AGUA / 110 MM	BRANCO/WHITE/BLANCO	1
PORTAS / DOORS / PUERTAS				
14-	3000002846	PORTA SS ALTA-35 CRIATIVA DIR BRA / 685 X 347 X 19 MM	AÇO/STEEL/ACERO - BRANCO/WHITE/BLANCO	1
15-	3000002850	PORTA SS ALTA-35 CRIATIVA ESQ BRA / 685 X 347 X 19 MM	AÇO/STEEL/ACERO - BRANCO/WHITE/BLANCO	1
FRENTE GAVETA / DRAWER FRONT / FRENTE DE CAJÓN				
16-	3000002539	FRENTE GAV-35 IG3G4 GDTL ANITA BRA / 347 X 168 X 21 MM AÇO	AÇO/STEEL/ACERO - BRANCO/WHITE/BLANCO	4
	3000002543	FRENTE GAV-35 IG3G4 GDTL ANITA PTO / 347 X 168 X 21 MM	AÇO/STEEL/ACERO - PRETO/BLACK/NEGRO	4
17-	3000001336	FUNDO GAV IG-35TL ANITA BRA / 415 X 292 X 0,6 MM	AÇO/STEEL/ACERO - BRANCO/WHITE/BLANCO	4
PIA / SINK / LAVAPLATOS				
18-	1000004278	PIA INOX 1202X450MM FRT ARR / 1200 X 450 X 130 MM	INOX/STAINLESS STEEL/INOX	1

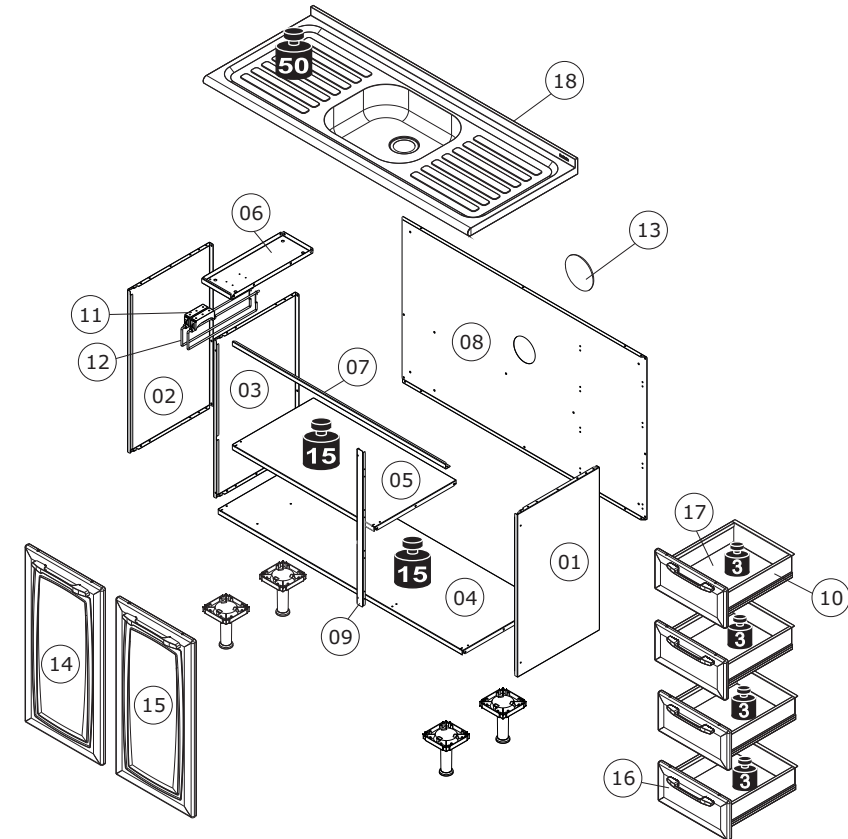

IG3G4GD-120 NC PIA
PRODUTO MONTADO: A: 0,89 L: 1,20 P: 0,45 M

FERRAGEM PUXADORES
HANDLE HARDWARE
HERRAJE TIRADORES

A11 - 1000000211 - 3,5x25 CP **12**

F27 - 3000004155 - 19 MM **12**
 **BUCHA PUXADOR**
HANDLE SCREW ANCHOR
TARUGO TIRADOR

F47 - 3000004163 - 6 MM **20**
 **BATOQUE PORTA - PVC**
PVC STOPPER
TOPE PARA PUERTA - PVC

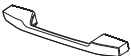
F76 - 1000000167 - 243 MM **06**
 **PUXADOR**
HANDLE
TIRADOR

MONTAGEM DE FRENTE

ASSEMBLY INSTRUCTIONS-CABINETS FRONT PORTION
ARMADO FRONTAL

MODELO 1 / PART 1 / MODELO 1

MODELO 2 / PART 2 / MODELO 2

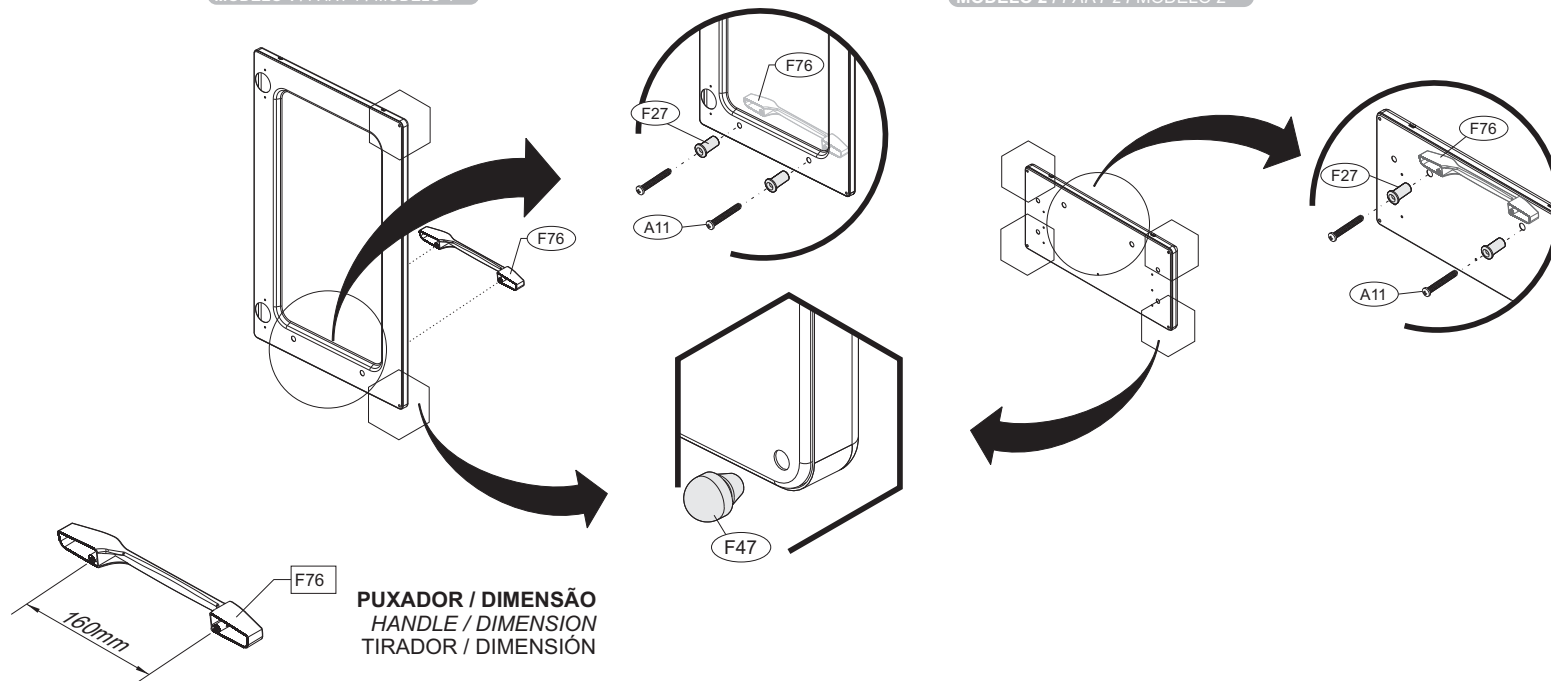

MONTAGEM DOS PÉS

LEGS ASSEMBLY
ARMADO DE LAS PATAS

A13 - 1000000227 - 3,5x14 CC **12**

F102 - 3000000061 - 120X120X18 MM-BRA **04**
 3000012136 - 120X120X18 MM-PTO
 **BASE PE PLASTICA**
LEG BASE
BASE DE PATA PLASTICA

F104 - 3000004172 - 158 MM **04**
 **PÉ ARMARIO**
FOOT CABINET
PATA

